

H-2VSD DUAL OUTPUT LED SUPER JET

USER MANUAL

1 BEFORE YOU BEGIN

1.1 What Is Included

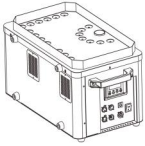

H-2VSD × 1

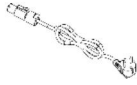

Power Cord × 1



Warranty Card × 1



User Manual × 1

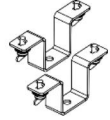



Omega bracket with
¼ turn fastener × 2

1.2 Unpacking Instructions

Carefully unpack the product immediately and check the container to make sure all the parts are in the package and are in good condition.

If the box or the contents (the product and included accessories) appear damaged from shipping, or show signs of mishandling, notify the carrier or dealer/seller immediately. In addition, keep the box and contents for inspection.

1.3 Symbols

| Symbol | Meaning |
|--|---|
|  | Caution Critical installation, configuration, or operation information. Not following these instructions may make the product not work, cause damage to the product, or cause harm to the operator. |
|  | Important Important installation or configuration information. Failure to comply with this information may keep the product from working correctly. |
|  | Information Useful information. |

1.4 Disclaimer

The information and specifications contained in this User Manual are subject to change without notice. DJPOWER assumes no responsibility or liability for any errors or omissions and reserves the right to revise or to create this manual at any time.

Copyright © 2018 DJPOWER. All rights reserved.

1.5 Safety Notes

Please read the following Safety Notes carefully before working with the product. The notes include important safety information about installation, usage, and maintenance.

1.5.1 Personal Safety

- Always connect the product to a grounded circuit to avoid the risk of electrocution.
- During heating up and operation, the housing will be scalding hot. Do not touch.
- **The product is very hot during operation and it remains hot for a long time after operation has stopped. Do not touch the product's nozzle.**
- Make sure that children, unauthorised people and animals do not obtain access to the machine.
- **Avoid direct eye exposure to the light source while the product is on.**

1.5.2 Mounting and Rigging

- The product is for indoor use only! To prevent risk of fire or shock, do not expose the product to rain or moisture.
 - **To prevent leaking or spilling, always position the fluid tank with the tank's cap in the uppermost position above the tank's fluid line. Make sure the fluid never exceeds the max fluid level..**
- 
- CAUTION: When transferring product from extreme temperature environments, (e.g. cold truck to warm humid ballroom) condensation may form on the internal electronics of the product. To avoid causing a failure, allow product to fully acclimate to the surrounding environment before connecting it to power.
 - Do not mount the product on a flammable surface (linoleum, carpet, wood, paper, carton, plastic, etc.).
 - Do not use in a confined space. Always install the product in a location with adequate ventilation, at least 20 in (50 cm) from adjacent surfaces.
 - When hanging this product, always secure to a fastening device using a safety cable.
 - Be sure that no ventilation slots on the product's housing are blocked or clogged by dust. If necessary, remove the dust.

1.5.3 Power and Wiring

- Always make sure that the voltage of the outlet to which you are connecting the product is within the range stated on the decal or rear panel of the product.
- Make sure the power cord is not crimped or damaged.
- Never connect this product to a dimmer pack or rheostat.
- Never disconnect the product from power cord by pulling or tugging on the cord.
- To eliminate unnecessary wear and improve its lifespan, during periods of non-use completely disconnect the product from power via breaker or by unplugging it

1.5.4 Operation

- Do not operate this product if you see damage to the housing or cables. Have the damaged parts replaced by an authorized technician at once.
- Do not use the product as a space heater.

- The maximum ambient temperature (Ta) is 104 °F (40 °C). Do not operate the product at higher temperatures.
- **Do not cover the ventilation slots when operating to avoid internal overheating.**
- **Do not cover or plug the output nozzle during operation.**
- Wipe up spitted fluid immediately. Moisture – also fluid – can destroy the electric.
- You may hear a loud popping sound during operation. This is normal.
- Never carry the product by the power cord or any moving part. Always use the handles of the machine.
- **Drain the tank before transporting the product.**
- Always disconnect the product from the power source before cleaning.
- In the event of a serious operating problem, stop using the product immediately.
- This product contains no user-serviceable parts. Any reference to servicing in this User Manual will only apply to properly trained, certified technicians. Do not open the housing or attempt any repairs which can lead to damage or malfunction.
- **Use only DJPOWER Consumable, fog fluid PRO-V is recommended.**



Keep this User Manual for future use. If you sell the product, be sure that the purchaser receives this document.

2 INTRODUCTION

2.1 Description

H-2VSD is World's First Dual Output LED Vertical Fog Machine Super-Jet, it is specially designed for professional stage, with the unique "super-jet" technology, the output speed and strength can even be comparable with CO2 jet.

To be DJPOWER's newest updated product, with "super-jet" patented technology, H-2VSD is twice the speed, twice the brightness, "Inner Flame Color Changing" technology enables independent color changes for flame core! User-friendly LCD display and operation, it is perfect for large clubs, large stage productions, rental companies and production release conference.

2.2 Features

- Dual output for strong plume;
- Newest global patent "Super-Jet";
- "Immediate-Stop" and Anti-Squirting Plus patent technology;
- Independent color changes for flame core, two amazing colors of jet;
- 37pcs 8W RGBA LEDs, twice the brightness;
- Advanced No-Fluid protection;
- Anti-loose power plug;
- Built-in LCD control, and 3-pin, 5-pin DMX control;
- Please use DJPOWER professional thin fog fluid PRO-V.

2.3 Product Overview

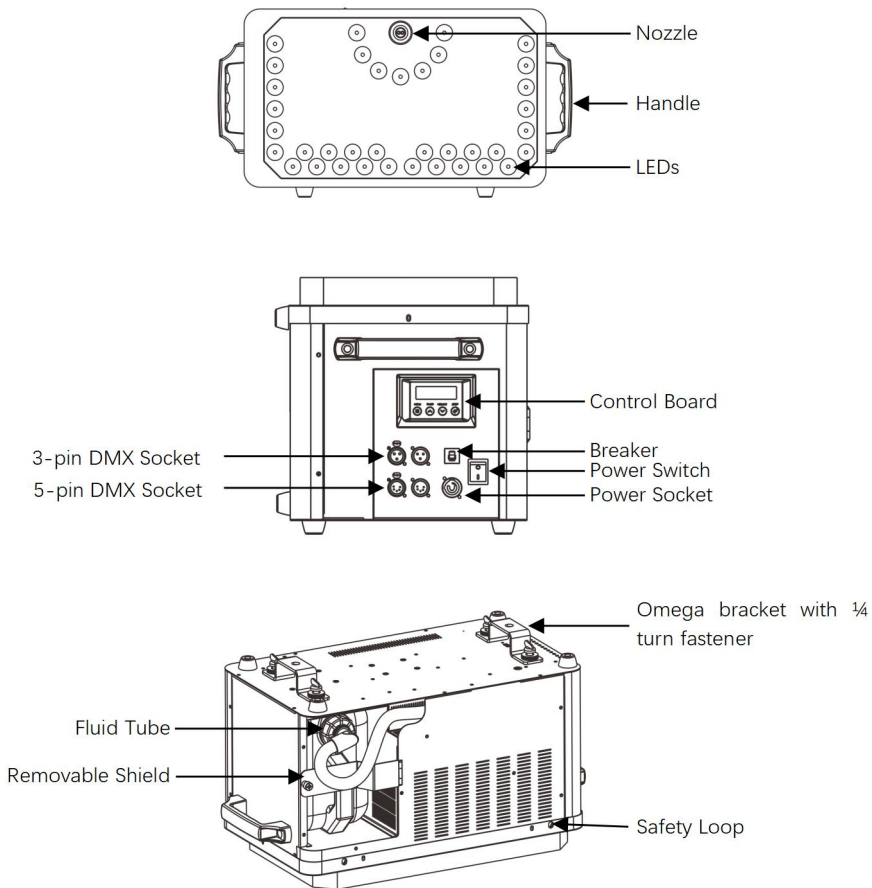

2.4 Product Dimensions

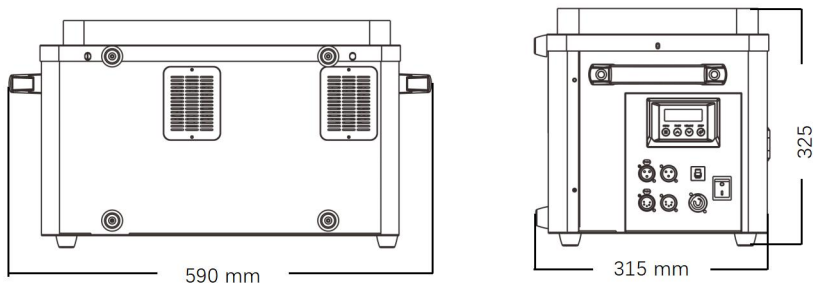

3 TECHNICAL SPECIFICATIONS

| | | |
|---------------------------------|---|-----------------------------|
| AC Power | Input Voltage & Rate | 220-240 V, 50/60 Hz |
| | Current Limiter Type | Breaker |
| | Current Limiter Specifications | 16 A, 250 V |
| | Total Power Consumption | 3,100 W |
| Heating | Heat Up Time | Appr. 9 min |
| Light Source | LED Color | RGBA |
| | LED Type | Quad-Color |
| | Power per LED | 8 W |
| | Quantity of LED | 37 pcs |
| | Quantity of Inner LED | 7 pcs |
| | Total Power of Inner LED | 56 W |
| | Quantity of Outer LED | 30 pcs |
| | Total Power of Outer LED | 240 W |
| Capacity | Fluid Tank Capacity | 5 L |
| | Output Duration with Fluid Tank Full | Appr. 10.0 min |
| Output | Adjustable Output | × |
| | Max Output Volume | Appr. 78,000 cuft /min |
| | Max Output Height | Appr. 12.0 m |
| | Fluid Consumption (100% Output) | Appr.400.0 ml/min |
| | Maximum Continuous Duration (100% Output) | Appr.10 S |
| | Continuous Output | × |
| | Cumulative Duration (Fully Loaded, 100% Output) | Appr.12.5 min |
| | Consumable Type for Standard Output Test | PRO-V |
| Placement & Mounting | Horizontal | √ |
| | Inclined | √ (ensure no fluid leaking) |
| | Vertical | √ |
| | Hang Upside Down | √ |
| | Rigging & Trussing | √ |
| Control | On-device Manual Control | Touch LCD control board |
| | Wireless Control | × |
| | Wired Control | × |
| | Control Protocol | DMX512 |
| | DMX Channel Range | 14 or 15 |
| | RFID Card | × |
| Certification | CE | √ |
| | RoHS | √ |
| Consumable | Consumable | PRO-V |
| Weight & Dimensions | Net Weight | 27.5 kg |
| | Gross Weight | 29.5 kg |
| | Machine Dimensions | 606 × 321 × 323.5 mm |
| | Packing Dimensions | 670 × 410 × 415 mm |

4 SETUP

4.1 AC Power

The machine has a fixed voltage power supply and can work with an input voltage of AC 220 V-240 V, 50/60 Hz, depending on the specific model.

To determine the product's power requirements (circuit breaker, power outlet, and wiring), use the current value listed on the label affixed to the product's back panel, or refer to the product's specifications chart. The listed current rating indicates the product's average current draw under normal conditions.



Always connect the product to a protected circuit (circuit breaker or fuse). Make sure the product has an appropriate electrical ground to avoid the risk of electrocution or fire.



Never connect the product to a rheostat (variable resistor) or dimmer circuit, even if the rheostat or dimmer channel serves only as a 0 to 100% switch.

4.2 AC Plug

The H-2VSD comes with a power input cord terminated with a Lockable Powercon connector on one end and an EU plug on the other end (EU & China market). If the power input cord that came with your product has no plug, or if you need to change the plug, use the table below to wire the new plug:

| Connection | Wire (U.S.) | Wire (Europe) |
|------------|--------------|---------------|
| AC Live | Black | Brown |
| AC Neutral | White | Blue |
| AC Ground | Green/Yellow | Green/Yellow |

4.3 Resetting the Breaker

This product is equipped with a resettable breaker. If the breaker trips, all sections of this product will lose power.

- Remove the power cord from mains power.
- Allow unit to cool for 15 minutes.
- After 15 minutes, you may attempt to reset the breaker by pressing the button with your finger.
- Plug the product's power cord into the power outlet and continue using as recommended.

4.4 DMX Linking

You can link the H-2VSD to a DMX controller using a 3- or 5-pin DMX connection. If using other DMX-compatible products with this product, you can control each individually with a single DMX controller. Instructions for connecting and configuring this product for DMX operation are in the User Manual.

4.5 Mounting

Before mounting the product, read and follow the safety recommendations indicated in the Safety Notes.

4.5.1 Orientation

Always mount this product in a safe position and make sure there is adequate room for ventilation, configuration, and maintenance. The H-2VSD should be suspended upright or upside down using the 2 Omega brackets included, or it can be placed on its rubber feet on a flat level surface.。



To prevent leaking or spilling, always position the fluid tank with the tank's cap in the uppermost position above the tank's fluid line



Make sure the fluid never exceeds the max fluid level.



4.5.1.1 Tank Inversion

To avoid leaking, invert the fluid tank when mounting this product in an inverted position.:

- Remove the screws and the bottle lock to take out the tank.
- Turn the fog machine upside down and reverse the fluid tank.
- secure the tank with the bottle lock.

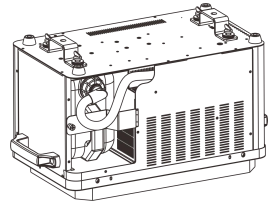

4.5.2 Complex Units

You can use two H-2VSD to make stronger effect (as the picture below).

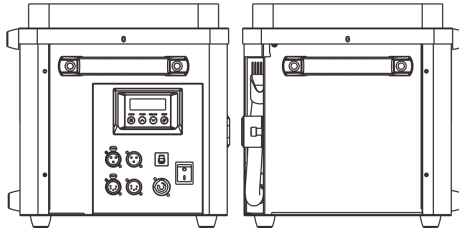
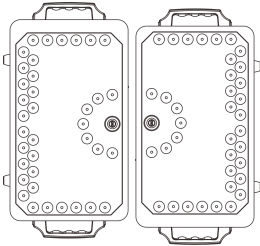

4.5.3 Rigging

DJPOWER recommends using the following general guidelines when mounting this product.

- Before deciding on a location for the product, make sure there is easy access to the product for maintenance and programming purposes.
- Make sure that the structure or surface onto which you are mounting the product can support the product's weight (see the Technical Specifications).
- When mounting the product on the floor, make sure that the product and cables are away from people and vehicles.
- When mounting the product overhead, always use a safety cable. Mount the product securely to a rigging point, whether an elevated platform or a truss.

5 OPERATION

5.1 Preparing for Operation

To prepare the H-2VSD for operation, perform the following steps.:

- After checking that all the parts are intact and complete, position the machine on flat.
- Withdraw the fluid tank from its compartment and remove its cap.
- Verify that the two plastic hoses attached to the cap are in place and in good condition.
- Pour DJPOWER PRO-V fog fluid into the tank (Do NOT exceed the max fluid level) and replace the cap.
- Return the tank back to its compartment in the H-2VSD.
- Make sure the plastic hose entering the H-2VSD from the fluid tank cap is not bent or kinked.
- Always connect the product to a grounded circuit. Before power on, make sure it is connected with the rated voltage.
- Turn on the machine, and "Heating Up" shows on the display during the heating-up process. After approx. 10 minutes, the display changes to "Ready to Fog" when the machine is ready to output.

5.2 On-device Control Panel

To access the control panel functions, use the four buttons located underneath the LCD display.

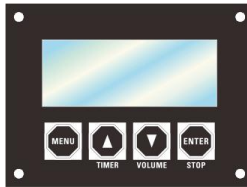

| Button | Function |
|----------|---|
| <MENU> | Switch menu pages to select a function |
| <TIMER> | Increases the numeric value of current function Triggers Timer output mode |
| <VOLUME> | Decreases the numeric value of current function Triggers Manual output mode. |
| <STOP> | Save settings STOP turns the fog output off |

5.3 On-device Control Mode & Operation

5.3.1 Programming

- Refer to the Menu Map to understand the menu options. The menu map shows the main level and a variable number of programming levels for each option.
- To go to the desired main level, press <MENU> repeatedly until the option shows on the display. This will take you to the first programming level for that option.

- To select an option or value within the current programming level, press <TIMER> or <VOLUME> until the option shows on the display. If there is another programming level, you will see that first option, or you will see the selected value.
- Press <MENU> repeatedly to switch menu pages.
- Press <STOP> to go back to Standby Page.

5.3.2 Manual Output Color

| Manual Output Color | Inner Color | Outer Color |
|---------------------|-------------|-------------|
| 1 | Red | Red |
| 2 | Green | Green |
| 3 | Blue | Blue |
| 4 | Amber | Amber |
| 5 | Green | Red |
| 6 | Blue | Red |
| 7 | Red | Green |
| 8 | Blue | Green |
| 9 | Red | Blue |
| 10 | Green | Blue |
| 11 | Amber | Red |
| 12 | Amber | Green |
| 13 | Amber | Blue |
| 14 | Red | Amber |
| 15 | Green | Amber |
| 16 | Blue | Amber |
| 17 | Auto color | Auto color |

5.3.3 Menu Map

| | Display | Description | Parameter Range |
|-----------------|----------------------------------|---|-----------------|
| Welcome Pages | DJPOWER Version 2 | Software version | |
| | Initializing.. DJPOWER H-2VSD | Initializing | |
| Preparing Pages | Heating Up >>>>> | The machine is heating up | |
| Standby Page | Ready to Fog DJPOWER H-2VSD | Finished heating up, ready to work. | |
| Settings Page | Timer Interval 115 S | Press “▲” or “▼” to set interval output of TIMER mode | 1-600 |

| | | | |
|--------------|----------------------------------|--|-----------------|
| | Timer Duration 6 S | Press "▲" or "▼" to set duration output of TIMER mode | 1-10 |
| | Manual Output Color 10 | Press "▲" or "▼" to set output color | 0-17 |
| | Fluid Sensor OFF | Press "▲" or "▼" to turn ON/OFF fluid sensor | ON/OFF |
| | DMX Address 1 | Press "▲" or "▼" to select DMX starting address | 1-512 |
| | DMX Address 14/15 Channel | Press "▲" or "▼" to select DMX starting address 14 and 15 Channel optional | 14/15 |
| | Language English | Press "▲" or "▼" to select language, and saved it by press | English/Chinese |
| Working Page | Interval 110 S DJPOWER H-2VSD | Interval output of TIMER mode | |
| | Duration 8 S DJPOWER H-2VSD | Duration output of TIMER mode | |
| | Volume DJPOWER H-2VSD | Output of VOLUME mode | |
| Warning Page | Lack of Fluid Please refill | Lack of fluid, and the display will flicker | |

5.4 DMX Mode & Operation DMX

The Machine H-2VSD works with a DMX controller.

- Connect the product to a suitable power outlet.
- Turn the product on.
- Connect a DMX cable from the DMX output of the DMX controller to the DMX input socket on the product.

5.4.1 Starting Address

When selecting a starting DMX address, always consider the number of DMX channels. If you choose a starting address that is too high, you could restrict the access to some of the product's channels.



DJPOWER® H-2VSD DMX set the starting address in the 001 - 512 DMX range and uses 14 DMX channels, which defines the highest configurable address to 499 to have all channels controllable.



Connect a DMX cable from the DMX output of the DMX controller to the DMX input socket on the product, or press repeatedly “MENU” button until the LCD shows “DMX Address”. Press “▲” or “▼” to set desired DMX starting address.

5.4.2 DMX Mode Menu Map

- When the machine connects to DMX, the display will always show DMX starting address, and you can set or change it at any time.



5.4.3 14 DMX Channel Assignments and Values DMX

| Channel | Function | Value | Description |
|---------|-------------------|-----------|--|
| 1 | Fog | 000 - 009 | No function |
| | | 010 - 255 | Fog on |
| 2 | Inner red | 000 - 009 | No function |
| | | 010 - 255 | Dim to bright |
| 3 | Inner green | 000 - 009 | No function |
| | | 010 - 255 | Dim to bright |
| 4 | Inner blue | 000 - 009 | No function |
| | | 010 - 255 | Dim to bright |
| 5 | Inner amber | 000 - 009 | No function |
| | | 010 - 255 | Dim to bright |
| 6 | Outer red | 000 - 009 | No function |
| | | 010 - 255 | Dim to bright |
| 7 | Outer green | 000 - 009 | No function |
| | | 010 - 255 | Dim to bright |
| 8 | Outer blue | 000 - 009 | No function |
| | | 010 - 255 | Dim to bright |
| 9 | Outer amber | 000 - 009 | No function |
| | | 010 - 255 | Dim to bright |
| 10 | Auto color | 000 - 009 | No function |
| | | 010 - 255 | Auto Color (Color 1-9 rotating every 1 second) |
| 11 | Auto color (IFCC) | 000 - 009 | No function |
| | | 010 - 255 | Auto Color (Color 1-9 rotating every 1 second) |
| 12 | Auto color | 000 - 009 | No function |
| | | 010 - 255 | Dim to fast |
| 13 | Strobe | 000 - 009 | No function |
| | | 010 - 255 | Slow to fast |
| 14 | Dimmer | 000 - 009 | No function |
| | | 010 - 255 | Dim to bright |

5.4.4 15 DMX Channel Assignments and Values DMX

| Channel | Function | Value | Description |
|---------|-----------------------|-----------|---|
| 1 | Fog | 000 - 009 | No function |
| | | 010 - 255 | Fog on |
| 2 | Inner red | 000 - 009 | No function |
| | | 010 - 255 | Dim to bright |
| 3 | Inner green | 000 - 009 | No function |
| | | 010 - 255 | Dim to bright |
| 4 | Inner blue | 000 - 009 | No function |
| | | 010 - 255 | Dim to bright |
| 5 | Inner amber | 000 - 009 | No function |
| | | 010 - 255 | Dim to bright |
| 6 | Outer red | 000 - 009 | No function |
| | | 010 - 255 | Dim to bright |
| 7 | Outer green | 000 - 009 | No function |
| | | 010 - 255 | Dim to bright |
| 8 | Outer blue | 000 - 009 | No function |
| | | 010 - 255 | Dim to bright |
| 9 | Outer amber | 000 - 009 | No function |
| | | 010 - 255 | Dim to bright |
| 10 | Auto color | 000 - 009 | No function |
| | | 010 - 255 | Auto Color (Color 1-9 rotating every 1 second) |
| 11 | Auto color (IFCC) | 000 - 009 | No function |
| | | 010 - 255 | Auto Color (Color 1-9 rotating every 1 second) |
| 12 | Auto color | 000 - 009 | No function |
| | | 010 - 255 | Dim to fast |
| 13 | Strobe | 000 - 009 | No function |
| | | 010 - 255 | Slow to fast |
| 14 | Dimmer | 000 - 009 | No function |
| | | 010 - 255 | Dim to bright |
| 15 | Safety master control | 000 - 049 | OFF |
| | | 050 - 200 | ON (After the safety master control is activated, the functions of channels 1-14 can be controlled normally.) |
| | | 201-255 | OFF |

5.5 Fluid Sensor

This machine uses software-based fluid sensor to detect whether there is fluid inside tube so as to protect the pump from being damaged. Turn on the "Fluid Sensor" to activate "No Fluid Protection" function.

5.5.1 Trigger "No-Fluid Protection"

When the Fluid Sensor is ON, the software-based "no-fluid protection" function will be activated. After the program continues to detect the machine working with no fluid inside the tube for 1 minute, the pump-shutoff will be activated with the flickering warning page showing on the screen.

5.5.2 Clear "No-Fluid Protection" Warning

When the machine is under the no-fluid protection, after refilling the fluid, there are three ways to clear the warning.

- Press and hold ENTER until the fluid is pumped and fill the tube.
- Under the DMX control mode, bring down channel 1 to OFF (value 0-9), then up to ON (value 10-255).
- Turn off "Fluid Sensor" in the menu.

6 TECHNICAL INFORMATION

6.1 Expected LED Lifespan

LEDs gradually decline in brightness over time, primarily due to heat. Packaged in clusters, LEDs exhibit higher operating temperatures than in ideal, single-LED conditions. For this reason, using clustered LEDs at their fullest intensity significantly reduces the LEDs' lifespan. Under normal conditions, this lifespan can be 40,000 to 50,000 hours. If extending this lifespan is vital, lower the operating temperature by improving the ventilation around the product and reducing the ambient temperature to an optimal operating range. In addition, limiting the overall projection intensity may also help to extend the LEDs' lifespan.

6.2 Maintenance

Do not allow the H-2VSD to become clogged. Dust build-up reduces light output performance and can cause overheating. This can lead to reduced light source life and increased mechanical wear. After every 40 hours of continuous operation, use a detergent composed of 35% vinegar and 65% distilled water through the system and spray 10-15 times after heat to prevent the accumulation of particulate matter in the heating element.

The recommended cleaning procedure is as follows.:

- 1) Unplug the product from power.
- 2) Empty all fluid from the machine.
- 3) Add cleaning solution to the tank.
- 4) Connect the product to power and allow it to warm up.
- 5) Run the product in a well-ventilated area until the tank is empty. Do not allow the pump to run dry.
- 6) Refill with fog fluid to continue using the H-2VD. Run the machine briefly to clear any cleaning solution from the pump and heater.

- 7) Excessive dust, fluid residue and dirt will degrade performance and cause overheating. Remove dust from air vents with air compressor, vacuum or soft brush. The casing could be cleaned by the damp cloth.



Test-run your DJPOWER® H-2VSD on a monthly basis to achieve the best performance.

6.3 Storage

6.3.1 Machine Storage

Before storing the machine, clean it as described in the cleaning procedure above; however, only follow steps 1 through 5. Do not refill the tank with fog fluid if storing the machine. Cleaning the system prior to storage will help prevent any particles from condensing inside the pump or heater while not in use.

